

Guide Rails Guías

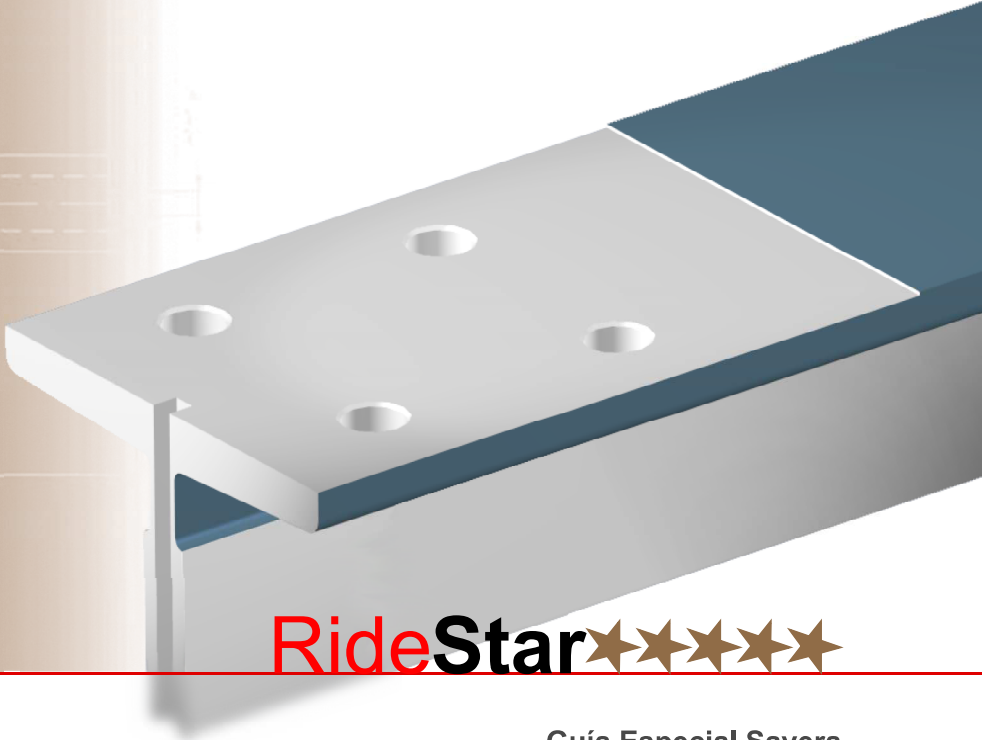

RideStar★★★★★

Guía Especial Savera
Special Savera Guide



Elevator System Solutions



RideStar★★★★★

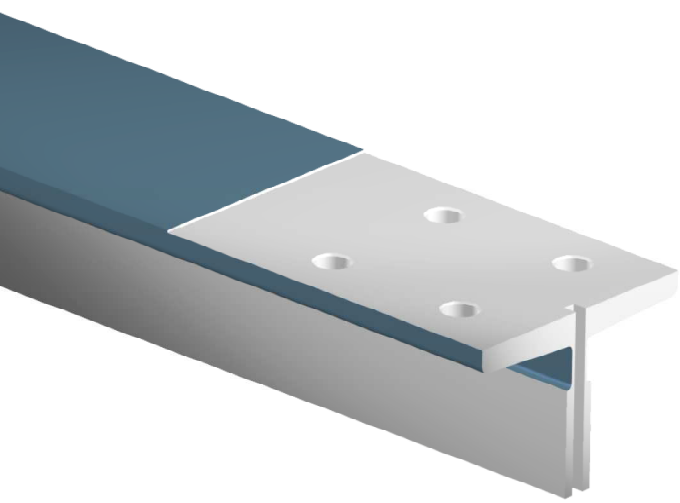

Guía Especial SAVERA

Savera completa con estas guías la gama de **alta calidad**, necesaria para dar total cobertura al mercado de **alta velocidad**. Su uso está especialmente recomendado para ascensores cuya velocidad supere los 4 m/s.

Savera, con un control 100% automático y en línea del enderezado y del mecanizado de los extremos, garantiza las tolerancias exigidas a esta línea de guías, **única en el mercado**.

Special SAVERA Guide

With this **Star Line**, Savera completes the range of **high quality guides** needed to fully service the **high-speed elevator** market. This line is especially recommended for lifts with speeds above 4 m/s.

With 100% automatic and on-line control in straightening and machining of the ends, Savera is able to guarantee the required tolerances for this guide line - **unique in the market**.

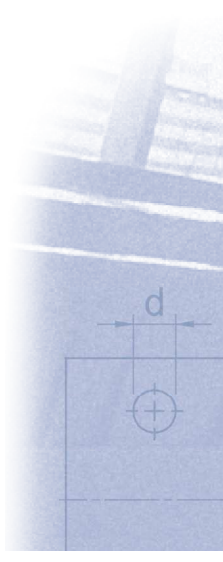

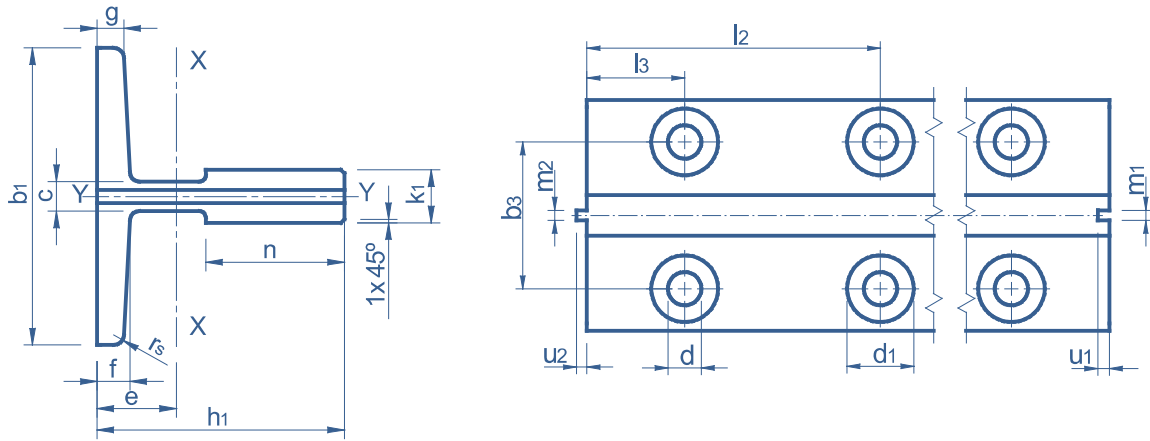

Dimensiones y distancias entre agujeros, placas y tornillos / Dimensions and distance between holes, fishplates and bolts

Dimensiones (mm)

Dimensions (mm)

	$b_1 \pm 1,50$	$h_1 \pm 0,75$	$h \pm 0,03$	$l \begin{smallmatrix} +3 \\ -0 \end{smallmatrix}$	$k_1 \begin{smallmatrix} +0,05 \\ -0 \end{smallmatrix}$	$n \begin{smallmatrix} +3 \\ -0 \end{smallmatrix}$	c	$g \pm 0,75$	$f \pm 0,75$	r_s	$m_1 \begin{smallmatrix} +0,02 \\ -0 \end{smallmatrix}$	$m_2 \begin{smallmatrix} +0 \\ -0,02 \end{smallmatrix}$	$u_1 \pm 0,10$	$u_2 \pm 0,10$	Enderezado/Straightness	
															f/5m max. mm	f/m max. mm
T125/B	125	82	81	156	16	42	10	9	12	4	6,4	6,38	7,14	6,35	0,5	0,2
T127-2/B	127	89	88	156	16	51	10	12,7	15,9	5	6,4	6,38	7,14	6,35	0,5	0,2
T140-1/B	140	108	107	193	19	51	12,7	12,7	15,9	5	6,4	6,38	7,14	6,35	0,5	0,2
T140-2/B	140	102	101	193	28,6	51	17,5	14,5	17,5	5	6,4	6,38	7,14	6,35	0,5	0,2
T140-3/B	140	127	126	193	31,75	57	19	17,5	25,4	5	6,4	6,38	7,14	6,35	0,5	0,2

Distancia entre agujeros, placas tornillos (mm)

Distance between holes, fishplates and bolts (mm)

	d	d ₁	b ₂	$b_3 \pm 0,20$	$l_1 \begin{smallmatrix} +3 \\ -0 \end{smallmatrix}$	$l_2 \pm 0,20$	$l_3 \pm 0,20$	$v \begin{smallmatrix} +3 \\ -0 \end{smallmatrix}$	Tornillo Bolt	Arandela Washer
T125/B	17	33	130	79,4	305	114,3	38,1	28	M16x60	A-16
T127-2/B	17	33	130	79,4	305	114,3	38,1	28	M16x60	A-16
T140-1/B	21	40	140	92,1	380	152,4	31,8	38	M20x80	A-20
T140-2/B	21	40	140	92,1	380	152,4	31,8	38	M20x80	A-20
T140-3/B	21	40	140	92,1	380	152,4	31,8	48	M20x80	A-20

Características técnicas

Technical Characteristics

	Sección Section cm 2	Peso Weight kg/m	e cm	Ixx cm 4	Wxx cm 3	ixx cm	Iyy cm 4	Wyy cm 3	iyy cm
T125/B	22,82	17,91	2,43	151	26,16	2,572	159,1	25,46	2,641
T127-2/B	28,72	22,55	2,478	201,7	31,17	2,64	229,9	36,2	2,829
T140-1/B	35,15	27,59	3,236	403,3	53,32	3,387	309,7	44,24	2,968
T140-2/B	43,21	33,92	3,484	456,7	68,01	3,251	358,2	51,18	2,879
T140-3/B	57,52	45,15	4,418	947,5	114,4	4,059	466,7	66,67	2,848

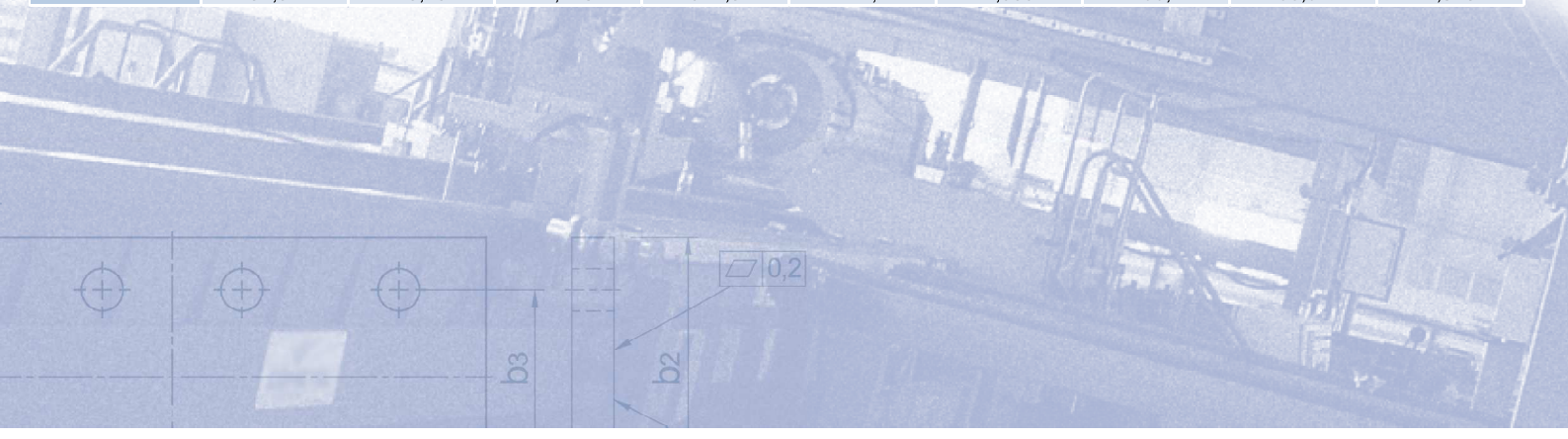

Placas especiales en catálogo Placas de Unión.
Special fishplates in Fishplates catalogue.

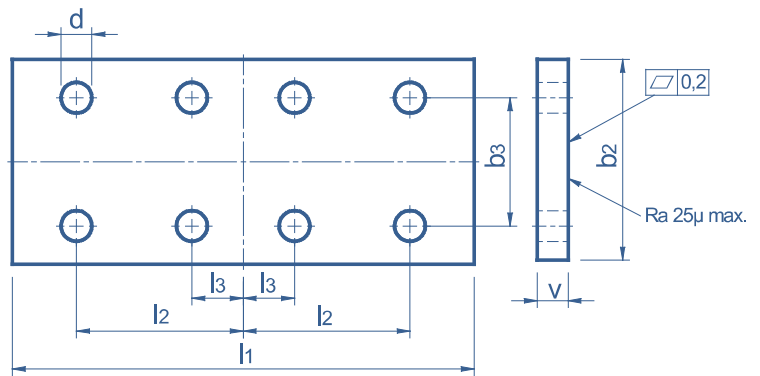
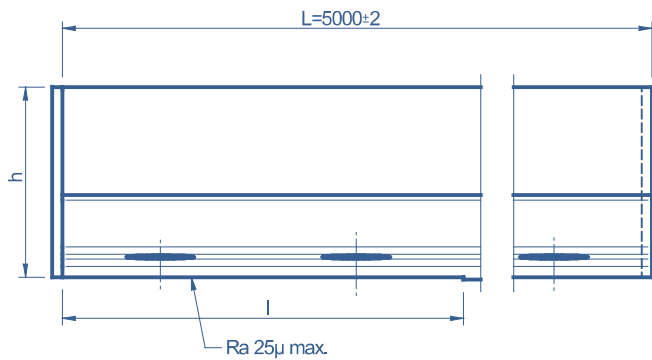

Placa estándar
Standard fishplate

ISO 7465:2007

Características Generales de las Guías
General Characteristics of the Guides

Normas Standards
ISO 7465
UNI 7465
ANSI A 17-1
BS 5655
DIN 15311
JIS
AFNOR NF P 82/251

Características Mecánicas / Mechanical Characteristics

	Carga de rotura Breaking point N/mm ²	Límite elástico Yield point N/mm ² min.	Alargamiento Elongation %
Hongo ≤16mm Blade ≤ 16mm	410 -520	275	≥ 22
Hongo >16mm Blade >16mm	410 -520	265	≥ 22

Composición Química
Chemical Composition

C% Max.	Mn% Max.	P% Max.	S% Max.	Si% Max.
0,21	1,5	0,045	0,045	0,4

Protección Antioxidante (*)
Anti-rust Protection (*)

Tipo Type	Espesor Thickness	Exterior meses Months outdoors	Interior meses Months indoors
Tectyl 511 M (aceite/oil)	2 - 10 µ	•	1 - 3
Tectyl 502 C (cera/wax)	20 - 30 µ	0 - 1	4 - 8
Tectyl 506 WD (cera/wax)	Estándar Standard	20 - 30 µ	1 - 3
	Especial Special	40 - 50 µ	3 - 6

(*)Datos orientativos que variarán en función de la humedad y salinidad del ambiente.





(*)Orientative data with change according to environment humidity and salinity.

Pesos (kg) y Empaquetado / Weights (kg) and Packing

Código Code	Peso/ guía Weight/ guide	Peso/guía con embalaje Weight/packed guide	Peso/guía con accesorios y embalaje Weight/packed guide and accessories	Nº guías/ paquete No.of guides per bundle	Nº guías por contenedor de 20 pies No. of guides per 20ft container	
					Con accesorios With accessories	Sin accesorios Without accessories
T125/B	89,55	90,55	97,83	10	220	230
T127-2/B	112,75	113,75	121,03	10	170	190
T140-1/B	137,95	139,95	153,13	5	135	150
T140-2/B	169,6	171,6	184,78	5	115	125
T140-3/B	225,75	227,75	243,57	5	85	90

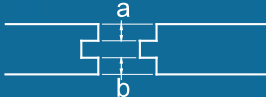
Eliminación Antioxidante / Anti-rust Protection Removal

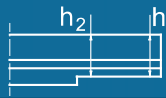
Producto Product	Solubilidad en el agua (% en peso) Solubility in water (% weight)
Disolvente Tectyl TFR Tectyl Solvent TFR	50

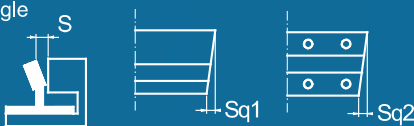
	Parámetro Parameter	Cepillado Machined Tolerancia/Tolerance
Enderezado Straightening 	Datos indicados en tabla de "Dimensiones" Data indicated in "Dimensions" table	
Centrado Centering 	a - b	±0,03 mm
Altura guía Guide height 	h	±0,03 mm
Paralelismo planeado Parallelism base 	h - h ₂	±0,05 mm
Holgura máxima macho - hembra Maximum clearance key - keyway 	E max.	0,06 mm
Rugosidad Roughness	Ra Long.	1,6 μ max.
	Ra Transv.	0,8 - 3,2 μ
Reviro Twist 	R max	1 mm / 5 m
Escuadra Angle 	s max.	±0,05 mm
	sq1	±0,10 mm
	sq2	±0,05 mm

Características / Characteristics

Suministro Supply	Protección Protection	Long. Length	Placas Fishplates
Embalaje • Chapa con tornillos • P.E.Foam • 4 maderas en parte inferior • Capuchones • Separadores Opcional -Protector envolvente	• Pintura azul • Tectyl 506 WD Opcional -Tectyl 502 C -Tectyl 511 M	5 m.	Placa estándar
Packing • Steel sheet with bolts • P.E. Foam • 4 wooden blocks at the bottom • Caps • Spacers Optional -Cover protection	• Blue paint • Tectyl 506 WD Options -Tectyl 502 C -Tectyl 511 M	5 m.	Standard fishplate

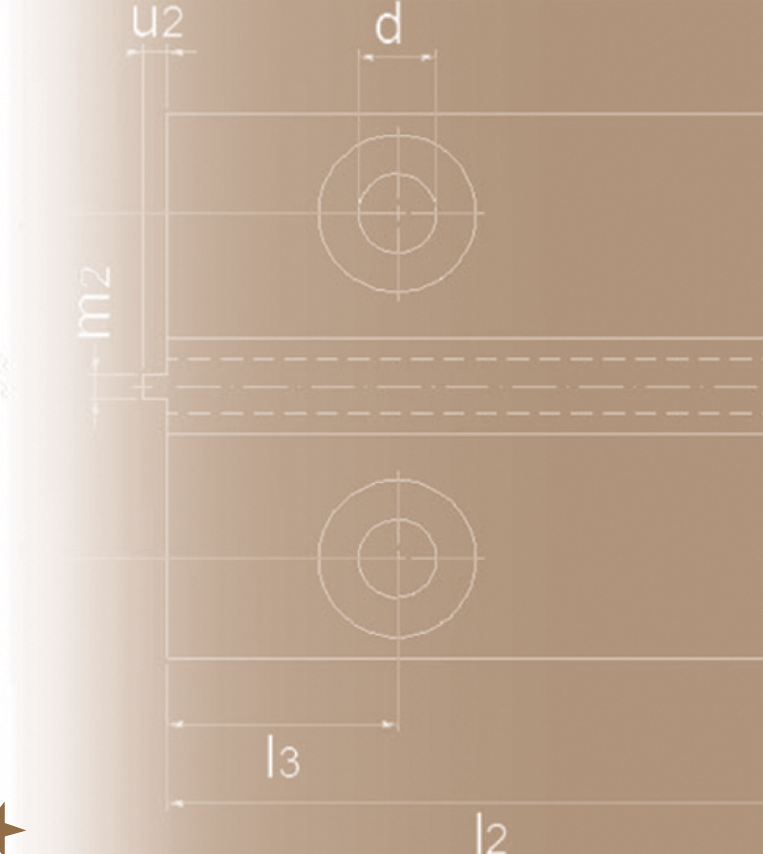

RideStar ★★★★★

Guía Especial Savera
Special Savera Guide

Rev. 01/16 - ISO 7465:2007
Actualización vigente disponible en : www.saveragroup.com
Current updates available on : www.saveragroup.com

Bº de Zalain 31780 Bera - Navarra . Spain
Tel. +34 948 626 900 - Fax +34 948 626 904
savera@saveragroup.com



Elevator System Solutions